

# S3M0040120T

## 1200V SiC POWER MOSFET

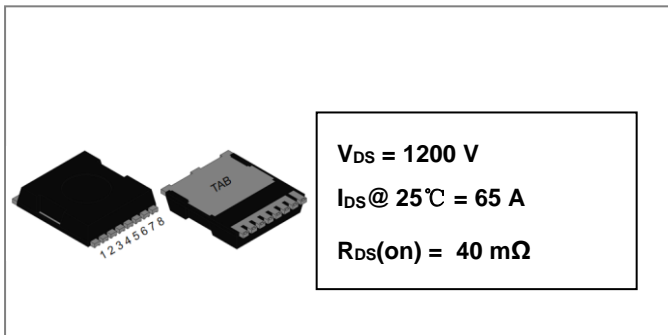

### Description

S3M0040120T is a single SiC Power MOSFET packaged in TOLL case. The device is a high voltage n-channel enhancement mode MOSFET that has very low total conduction losses and very stable switching characteristics over temperature extremes. The S3M0040120T is ideal for energy sensitive, high frequency applications in challenging environments.

### Circuit Diagram

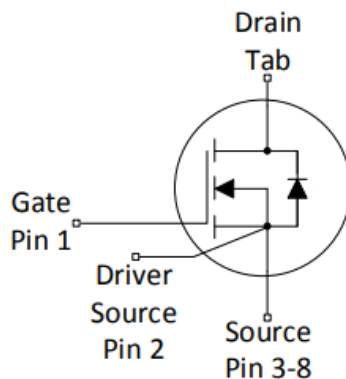

### Features

- Positive temperature characteristics, easy to parallel.
  - Low on-resistance typ.  $R_{DS(on)} = 40\text{m}\Omega$ .
  - Fast switching speed and low switching losses.
  - Very fast and robust intrinsic body diode.
  - Process of non-bright tin electroplating
- “-A” is an AEC-Q101 qualified device

### Applications

- EV Fast Charging Modules
- EV On Board Chargers
- Solar Inverters
- Online UPS/Industrial UPS
- SMPS (Switch Mode Power Supplies)
- DC-DC Converters
- ESS (Energy Storage Systems)

**Maximum Ratings ( $T_A = 25\text{ }^\circ\text{C}$ , unless otherwise specified)**

Characteristics	Symbol	Conditions	Min.	Typ.	Max.	Units	Note
Drain - Source Voltage	$V_{DSmax}$	$V_{GS} = 0\text{ V}$ , $I_D = 100\text{ }\mu\text{A}$			1200	V	
Gate - Source Voltage (dynamic)	$V_{GSmax}$	AC ( $f > 1\text{ Hz}$ )	-8		+20	V	
Gate - Source Voltage (static)	$V_{GSop}$	Static		-4 / +18		V	[1]
Continuous Drain Current	$I_D$	$V_{GS} = 18\text{ V}$ , $T_C = 25\text{ }^\circ\text{C}$			65	A	
		$V_{GS} = 18\text{ V}$ , $T_C = 100\text{ }^\circ\text{C}$			46		
Pulsed Drain Current	$I_{D(pulse)}$	Pulse width $t_P$ limited by $T_{jmax}$			223	A	
Power Dissipation	$P_D$	$T_C = 25\text{ }^\circ\text{C}$			130	W	

[1] Recommended turn off gate voltage is -4 V. Recommended turn on gate voltage is 18 V. Do not use with  $V_{GSon} < 12\text{ V}$ .

**Electrical Characteristics ( $T_A = 25\text{ }^\circ\text{C}$ , unless otherwise specified)**

Characteristics	Symbol	Conditions	Min.	Typ.	Max.	Units
Drain Source Breakdown Voltage	$V_{(BR)DSS}$	$V_{GS} = 0\text{ V}$ , $I_D = 100\text{ }\mu\text{A}$	1200			V
Gate Threshold Voltage	$V_{GS(th)}$	$V_{DS} = V_{GS}$ , $I_D = 16\text{ mA}$	2	2.5	4	V
		$V_{DS} = V_{GS}$ , $I_D = 16\text{ mA}$ , $T_J = 175\text{ }^\circ\text{C}$		1.7		V
Zero Gate Voltage Drain Current	$I_{DSS}$	$V_{DS} = 1200\text{ V}$ , $V_{GS} = 0\text{ V}$		1	100	$\mu\text{A}$
Gate Source Leakage Current	$I_{GSS}$	$V_{GS} = 18\text{ V}$ , $V_{DS} = 0\text{ V}$		10	250	nA
Drain Source On-State Resistance	$R_{DS(on)}$	$V_{GS} = 18\text{ V}$ , $I_D = 40\text{ A}$		40	52	m $\Omega$
		$V_{GS} = 18\text{ V}$ , $I_D = 40\text{ A}$ , $T_J = 175\text{ }^\circ\text{C}$		50		m $\Omega$
Transconductance	gfs	$V_{DS} = 20\text{ V}$ , $I_{DS} = 40\text{ A}$		18		S
		$V_{DS} = 20\text{ V}$ , $I_{DS} = 40\text{ A}$ , $T_J = 175\text{ }^\circ\text{C}$		19		S
Input Capacitance	$C_{ISS}$	$V_{GS} = 0\text{ V}$		2844		pF
Output Capacitance	$C_{OSS}$	$V_{DS} = 1000\text{ V}$		134		
Reverse Transfer Capacitance	$C_{RSS}$	$V_{AC} = 25\text{ mV}$		17		
$C_{OSS}$ Stored Energy	$E_{OSS}$	$f = 1\text{ MHz}$		78		
Turn-On Switching Energy	$E_{ON}$	$V_{DS} = 800\text{ V}$ , $V_{GS} = -4 / 18\text{ V}$		212		$\mu\text{J}$
Turn-Off Switching Energy	$E_{OFF}$	$I_D = 40\text{ A}$ , $R_{G(ext)} = 2.5\text{ }\Omega$ , $L = 99\text{ }\mu\text{H}$		198		
Turn-On Delay Time	$t_{d(on)}$	$V_{DS} = 800\text{ V}$ , $V_{GS} = -4 / 18\text{ V}$		12.5		ns
Rise Time	$t_r$	$I_D = 40\text{ A}$ , $R_{G(ext)} = 2.5\text{ }\Omega$		14.7		

**Technical Data**  
**Data Sheet N2848, REV.-**

**RoHS**

Turn-Off Delay Time	$t_{d(off)}$	Inductive Load Timing relative to VDS Per IEC60747-8-4 pg 83	27.5		
Fall Time	$t_f$		7.0		
Internal Gate Resistance	$R_{G(int)}$	$f = 1 \text{ MHz}, AC = 25 \text{ mV}$	1.3		$\Omega$
Gate to Source Charge	$Q_{gs}$	$V_{DS} = 800 \text{ V}, V_{GS} = -4 / 18 \text{ V}$ $I_D = 40 \text{ A}$ Per IEC60747-8-4 pg 21	66		nC
Gate to Drain Charge	$Q_{gd}$		49		
Total Gate Charge	$Q_g$		143		

**Reverse Diode Characteristics ( $T_A = 25 \text{ }^\circ\text{C}$ , unless otherwise specified)**

Characteristics	Symbol	Conditions	Typ.	Max.	Units
Diode Forward Voltage	$V_{SD}$	$V_{GS} = -4 \text{ V}, I_{SD} = 20 \text{ A}$	4.3		V
	$V_{SD}$	$V_{GS} = -4 \text{ V}, I_{SD} = 20 \text{ A}, T_J = 175^\circ\text{C}$	3.6		V
Continuous Diode Forward Current	$I_S$	$V_{GS} = -4 \text{ V}, T_C = 25 \text{ }^\circ\text{C}$	48		A
Reverse Recovery Time	$t_{rr}$	$V_{GS} = -4 \text{ V}, I_{SD} = 40 \text{ A}, T_J = 25 \text{ }^\circ\text{C}$ $V_R = 800\text{V}$ $dif / dt = 3000 \text{ A} / \mu\text{s}$	16		ns
Reverse Recovery Charge	$Q_{rr}$		221		nC
Peak Reverse Recovery Current	$I_{mm}$		23		A

## Thermal-Mechanical Specifications

Characteristics	Symbol	Condition	Specification	Units
Junction Temperature	$T_J$	-	-55 to +175	°C
Storage Temperature	$T_{stg}$	-	-55 to +175	°C
Typical Thermal Resistance Junction to Case	$R_{\theta JC}$	DC operation	0.31	°C/W

## Ordering Information

Device	Package	Shipping
S3M0040120T	TOLL	1800pcs/reel

## Marking Diagram

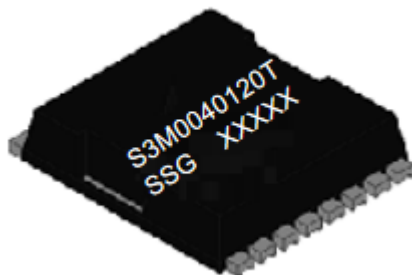

Where XXXXX is YYWWL

S3M = Device Type  
 0040 = R<sub>bs(on)</sub>  
 120 = Reverse Voltage (1200V)  
 T = Package  
 SSG = SSG  
 YY = Year  
 WW = Week  
 L = Lot Number

**Cautions:** Molding resin  
 Epoxy resin UL:94V-0

**Ratings and Characteristics Curves**

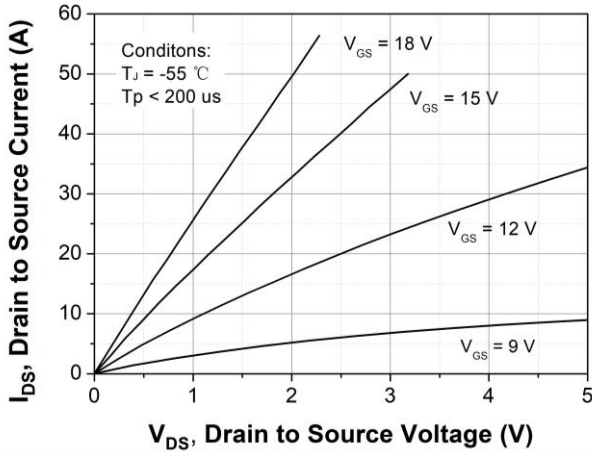

Figure 1. Output Characteristics  $T_J = -55\text{ }^\circ\text{C}$

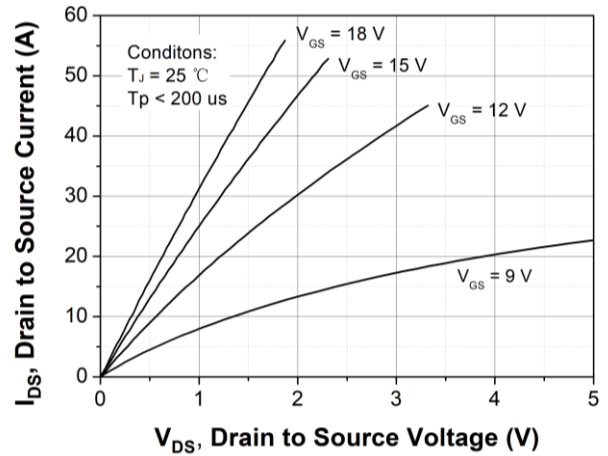

Figure 2. Output Characteristics  $T_J = 25\text{ }^\circ\text{C}$

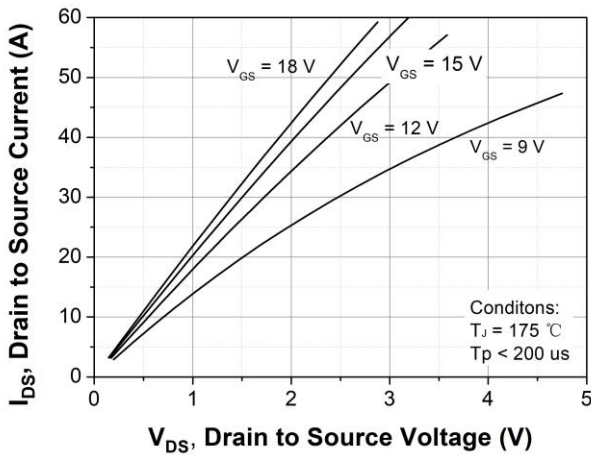

Figure 3. Output Characteristics  $T_J = 175\text{ }^\circ\text{C}$

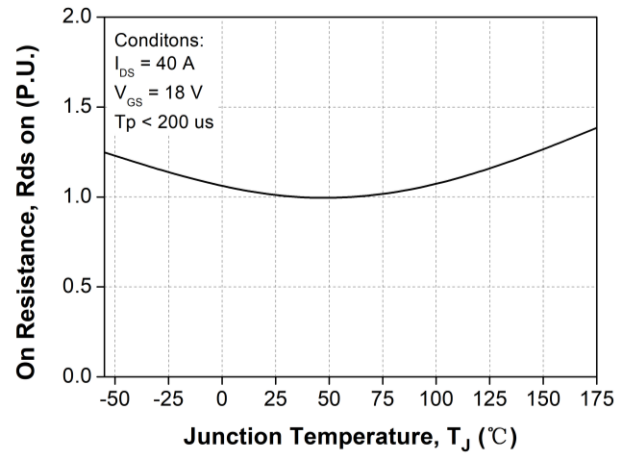

Figure 4. Normalized On-Resistance vs. Temperature

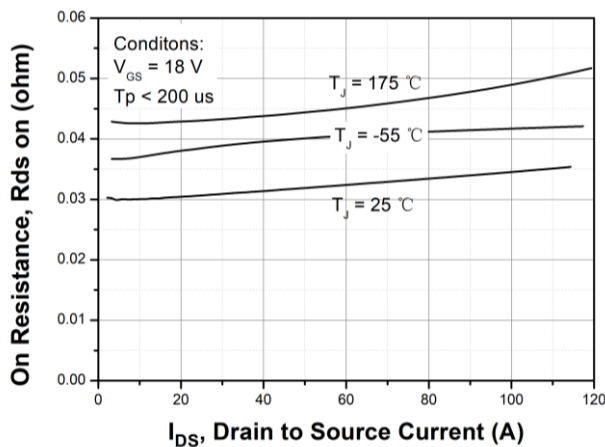

Figure 5. On-Resistance vs. Drain Current For Various Temperatures

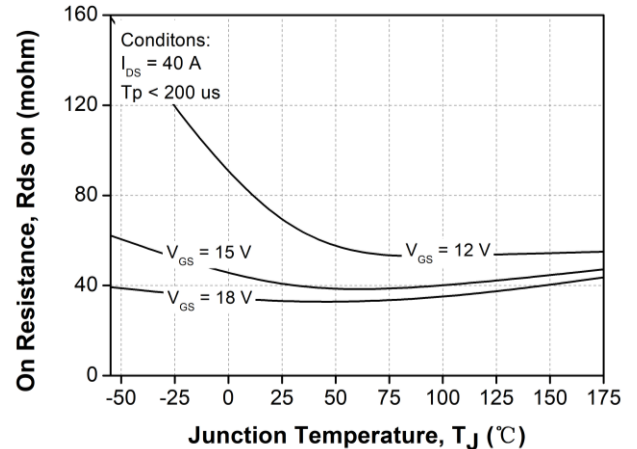

Figure 6. On-Resistance vs. Temperature For Various Gate Voltage

Technical Data  
Data Sheet N2848, REV.-

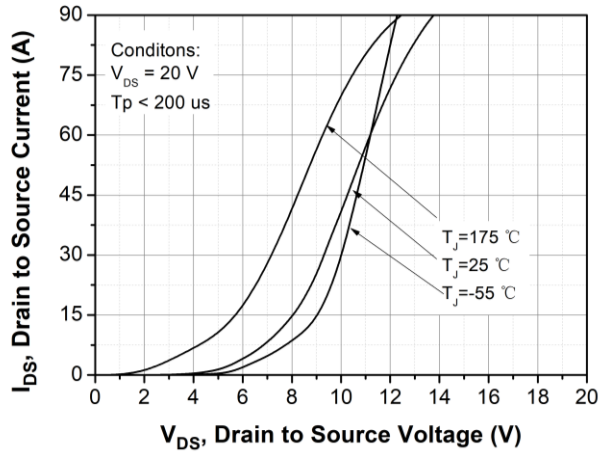

Figure 7. Transfer Characteristic for Various Junction Temperatures

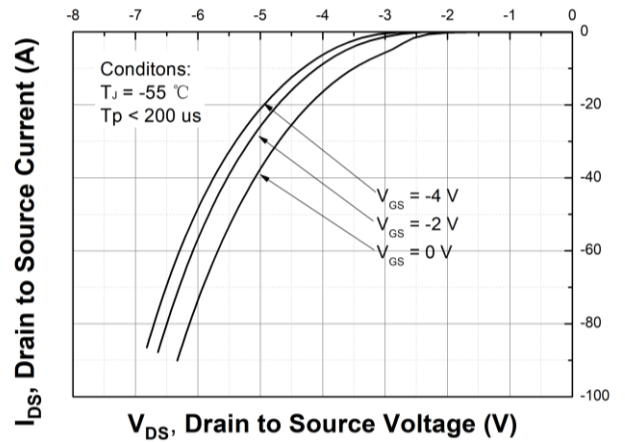

Figure 8. Body Diode Characteristic at  $T_J = -55\text{ }^\circ\text{C}$

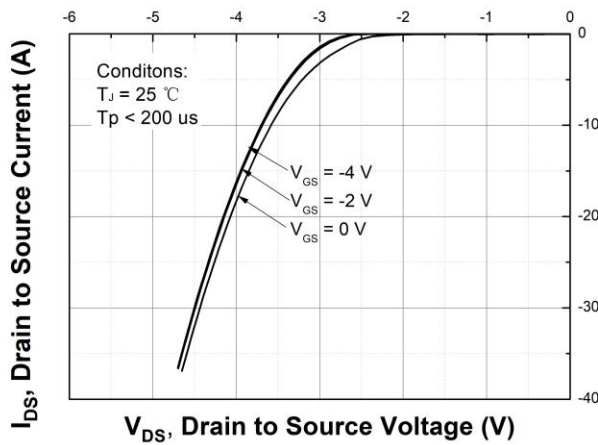

Figure 9. Body Diode Characteristic at  $T_J = 25\text{ }^\circ\text{C}$

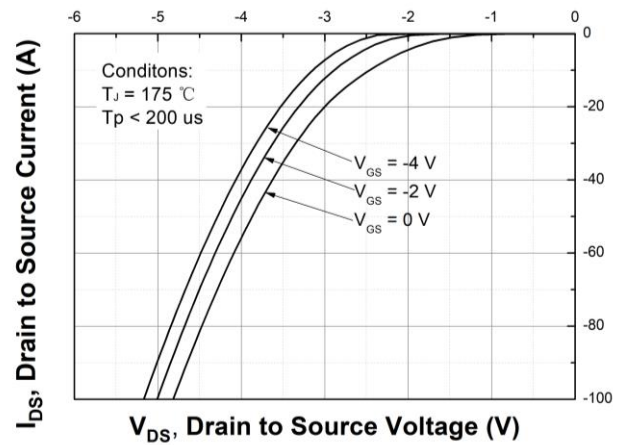

Figure 10. Body Diode Characteristic at  $T_J = 175\text{ }^\circ\text{C}$

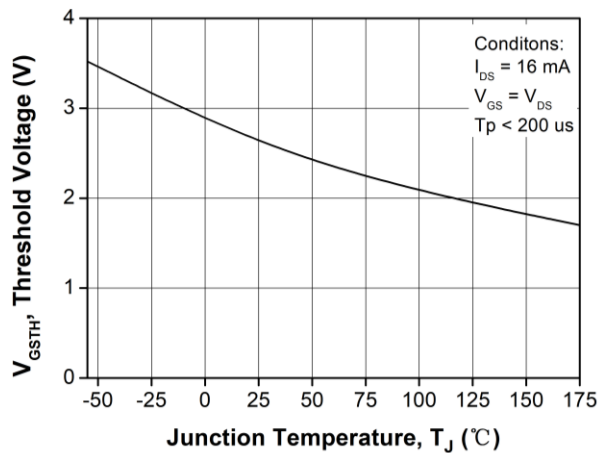

Figure 11. Threshold Voltage vs. Temperature

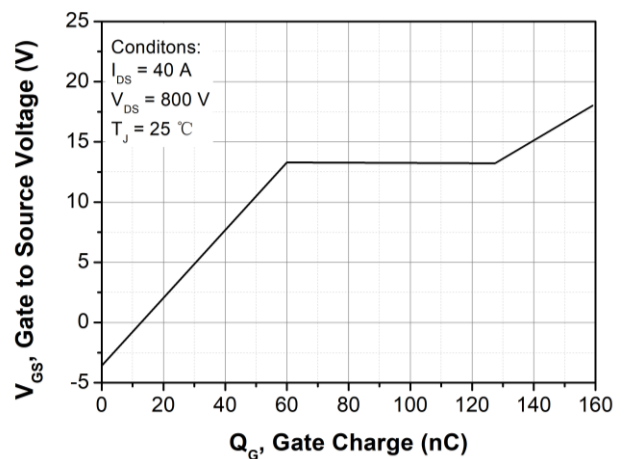
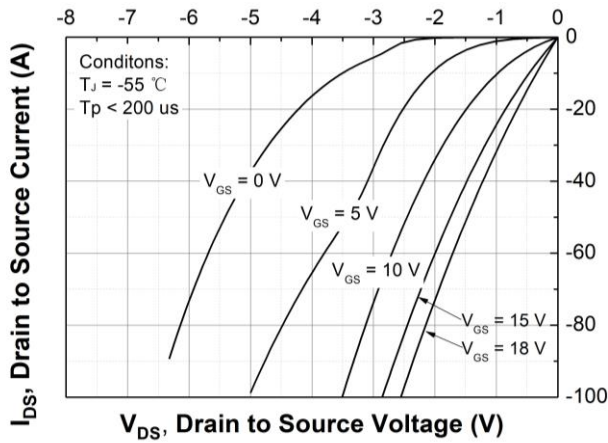
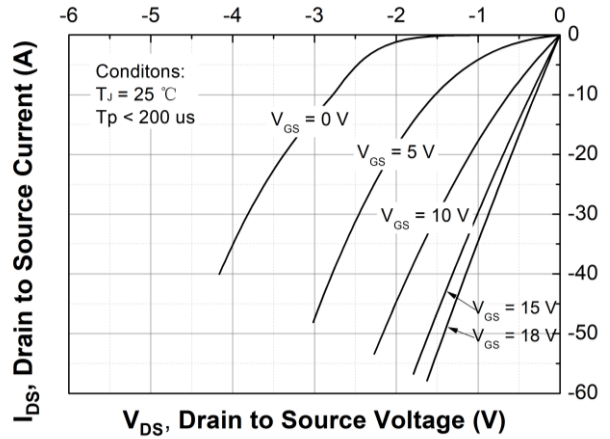

Figure 12. Gate Charge Characteristic

**Technical Data**  
**Data Sheet N2848, REV.-**



**Figure 13. 3rd Quadrant Characteristic at  $T_J = -55\text{ }^\circ\text{C}$**



**Figure 14. 3rd Quadrant Characteristic at  $T_J = 25\text{ }^\circ\text{C}$**

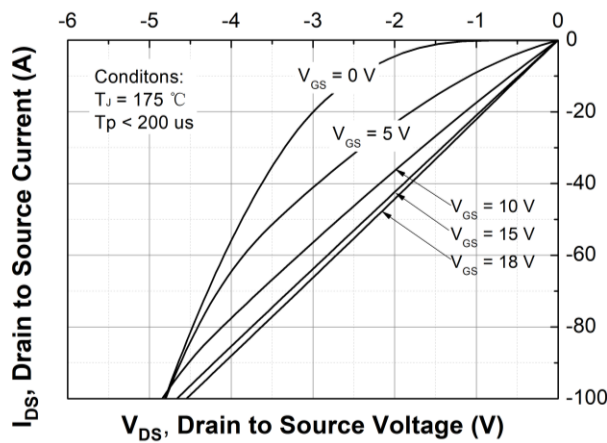

**Figure 15. 3rd Quadrant Characteristic at  $T_J = 175\text{ }^\circ\text{C}$**

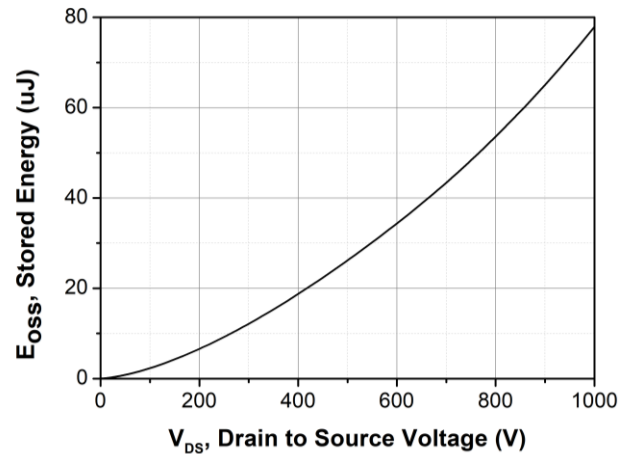

**Figure 16. Output Capacitor Stored Energy**

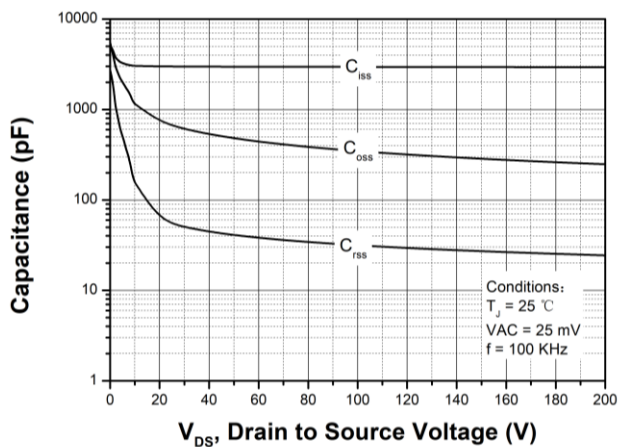

**Figure 17. Capacitances vs. Drain-Source Voltage (0 - 200 V)**

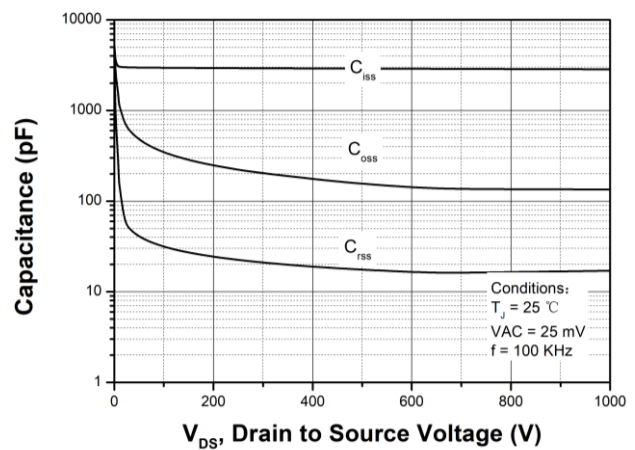

**Figure 18. Capacitances vs. Drain-Source Voltage (0 - 1000 V)**



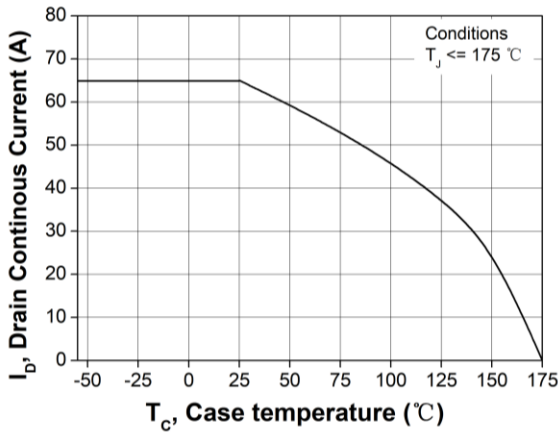

Figure 19. Continuous Drain Current Derating vs. Case Temperature

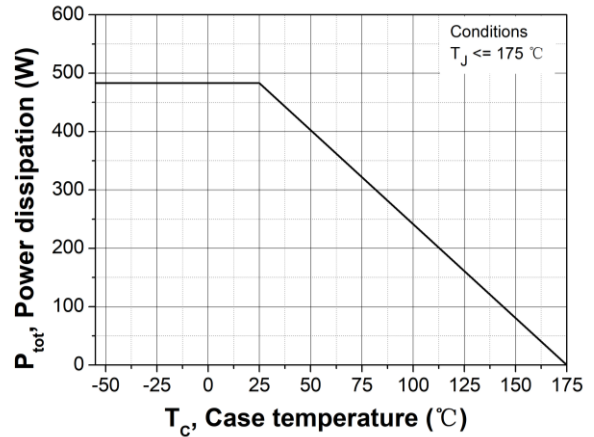

Figure 20. Maximum Power Dissipation Derating vs. Case Temperature

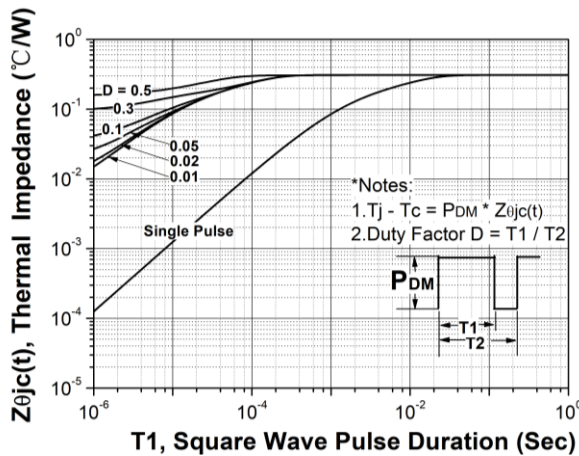

Figure 21. Transient Thermal Impedance (Junction - Case)

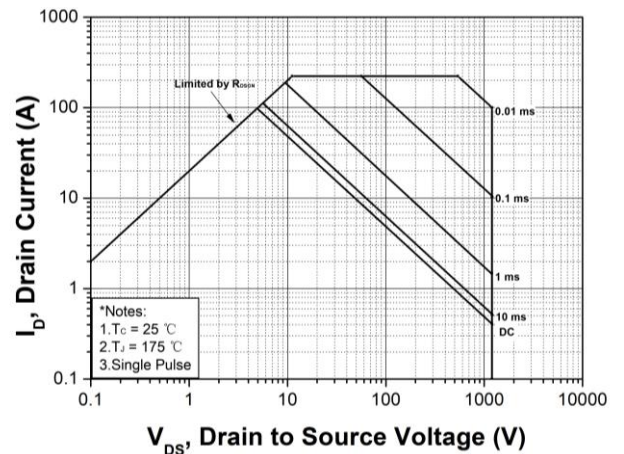

Figure 22. Safe Operating Area

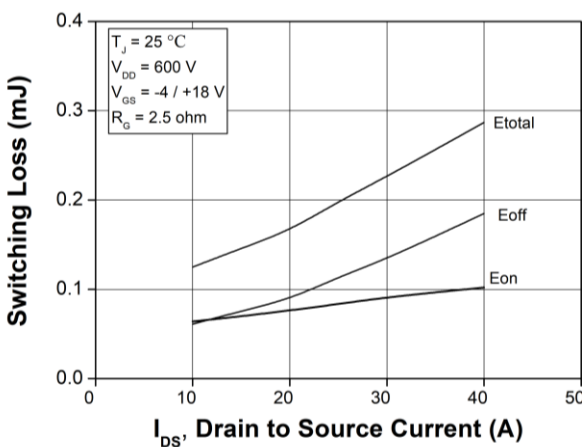

Figure 23. Clamped Inductive Switching Energy vs. Drain Current ( $V_{DD} = 600V$ )

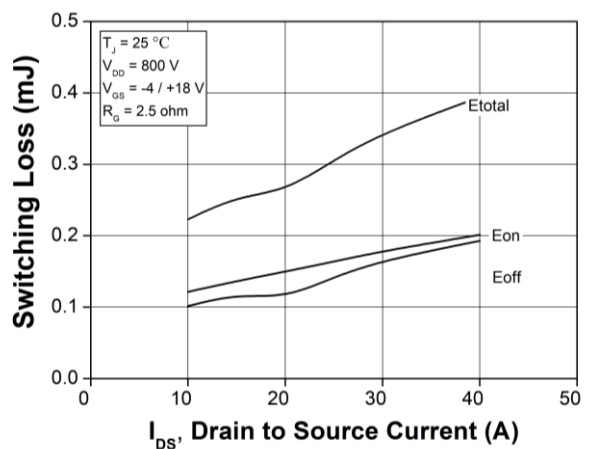

Figure 24. Clamped Inductive Switching Energy vs. Drain Current ( $V_{DD} = 800V$ )

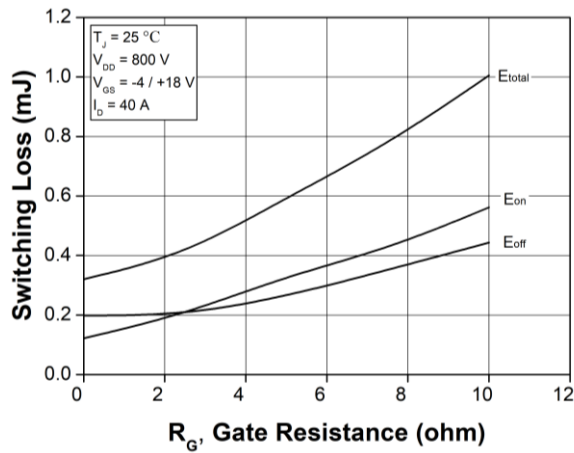

Figure 25. Clamped Inductive Switching Energy vs.  $R_{G(ext)}$

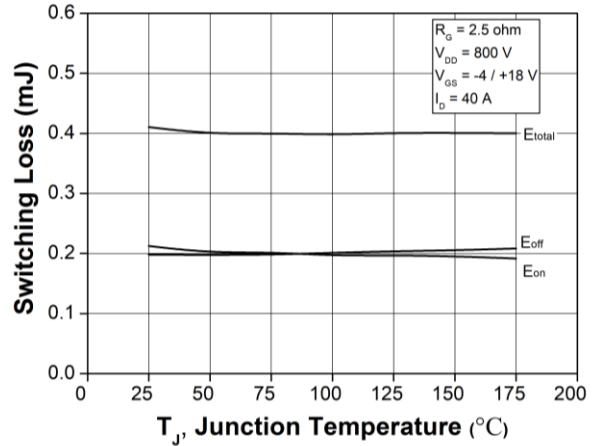

Figure 26. Clamped Inductive Switching Energy vs. Temperature

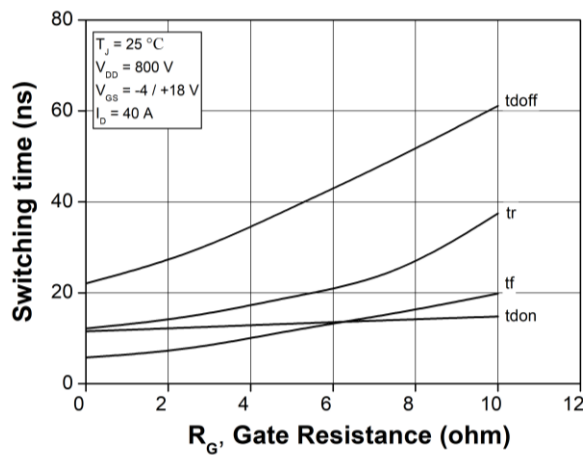

Figure 27. Switching Times vs.  $R_{G(ext)}$

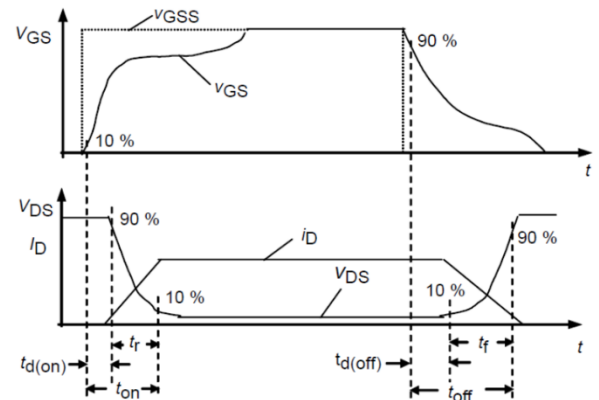
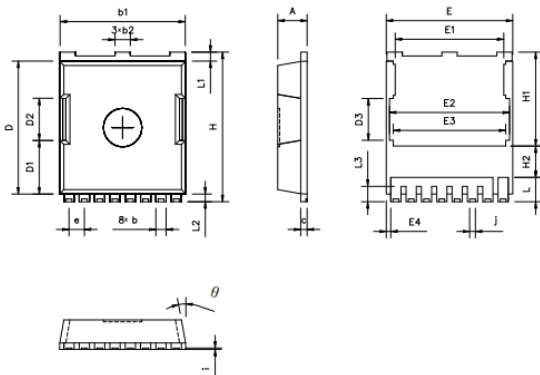

Figure 28. Switching Times Definition

**Mechanical Dimensions TOLL**



SYMBOL	Dimensions In Millimeters		
	Min.	NOM.	Max.
A	2.20	2.30	2.40
b	0.70	0.80	0.90
b1	9.70	9.80	9.90
b2	1.20 REF.		
c	0.40	0.50	0.60
D	10.28	10.38	10.48
D1	4.08	4.18	4.28
D2	3.20	3.30	3.40
D3	3.16	3.26	3.36
E	9.80	9.90	10.00
E1	8.40	8.50	8.60
E2	9.30	9.40	9.50
E3	8.8 REF.		
E4	0.25	0.35	0.45
e	1.20 BASIC		
H	11.58	11.68	11.78
H1	7.23	7.33	7.43
H2	2.45 REF.		
i	0.10	-	-
j	0.45 REF.		
L	1.60	1.90	2.10
L1	0.60	0.70	0.80
L2	0.50	0.60	0.70
L3	1.05	1.20	1.30
e	10° REF.		

**DISCLAIMER:**

- 1- The information given herein, including the specifications and dimensions, is subject to change without prior notice to improve product characteristics. Before ordering, purchasers are advised to contact the SMC Diode Solutions sales department for the latest version of the datasheet(s).
- 2- In cases where extremely high reliability is required (such as use in nuclear power control, aerospace and aviation, traffic equipment, medical equipment, and safety equipment), safety should be ensured by using semiconductor devices that feature assured safety or by means of users' fail-safe precautions or other arrangement.
- 3- In no event shall SMC Diode Solutions be liable for any damages that may result from an accident or any other cause during operation of the user's units according to the datasheet(s). SMC Diode Solution assumes no responsibility for any intellectual property claims or any other problems that may result from applications of information, products or circuits described in the datasheets.
- 4- In no event shall SMC Diode Solutions be liable for any failure in a semiconductor device or any secondary damage resulting from use at a value exceeding the absolute maximum rating.
- 5- No license is granted by the datasheet(s) under any patents or other rights of any third party or SMC Diode Solutions.
- 6- The datasheet(s) may not be reproduced or duplicated, in any form, in whole or part, without the expressed written permission of SMC Diode Solutions.
- 7- The products (technologies) described in the datasheet(s) are not to be provided to any party whose purpose in their application will hinder maintenance of international peace and safety nor are they to be applied to that purpose by their direct purchasers or any third party. When exporting these products (technologies), the necessary procedures are to be taken in accordance with related laws and regulations..